

LOW PROFILE OFFSET FOUR - WAY THROW

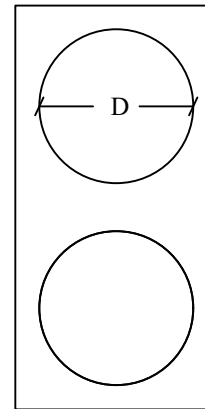
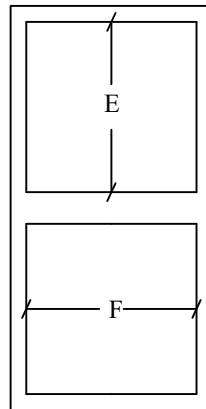
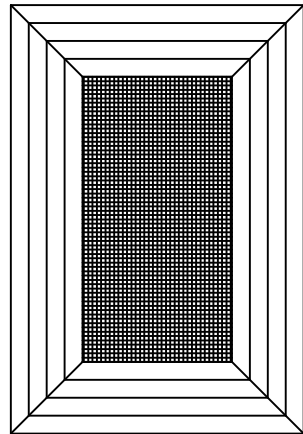
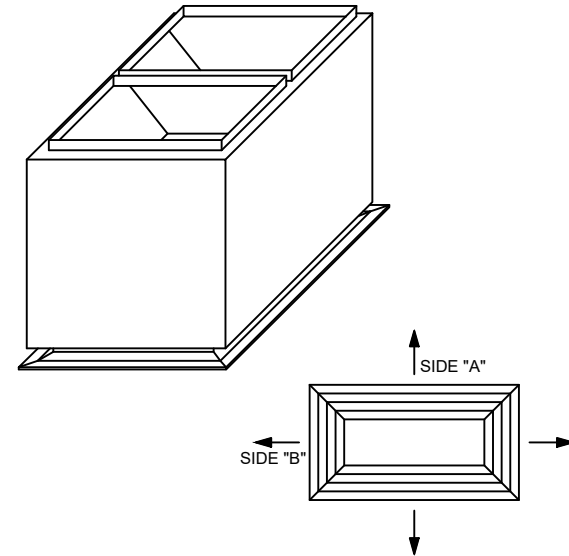
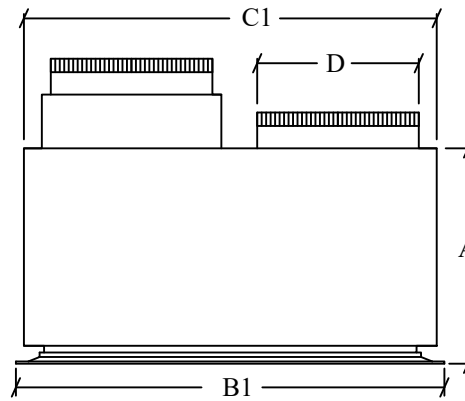
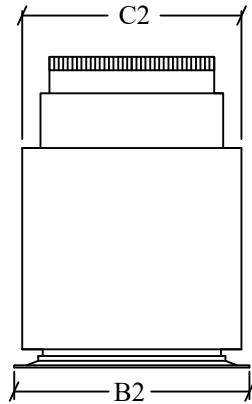

TYPICAL HARD DUCT CONNECTION OR TYPICAL FLEX DUCT CONNECTION

- STANDARD ITEMS:**
- 1: 2" THICK R-8 INTERNAL INSULATION
 - 2: HANGING BRACKETS
 - 3: PAINTED FACE (WHITE)

- OPTIONS:**
- 1: RECTANGLE HARD DUCT CONNECTION
 - 2: ROUND FLEX DUCT COLLARS (4.5" TALL)
 - 3: RETURN AIR DUCT SMOKE DETECTOR
 - 4: SUPPLY AIR DUCT SMOKE DETECTOR
 - 5: CLOSED CELL INSULATION
 - 6: STAINLESS STEEL CONSTRUCTION
 - 7: CUSTOM DUCT INLET SIZE _____

| MODEL# | "A" MIN THROW | "B" MIN THROW | "A" MAX THROW | "B" MAX THROW |
|-----------|---------------|---------------|---------------|---------------|
| FM4824-LP | 10-14-20 | - | 19-23-32 | - |
| FM4836-LP | 16-20-29 | - | 25-31-43 | - |

^ STANDARD SIZE ROUND COLLARS AS NOTED
SPECIFY IF 14" OR 16" COLLARS ARE REQUIRED

| MODEL# | A | B1 | B2 | C1 | C2 | D | E | F | RETURN* | CFM RANGE | NC |
|-----------|-------|--------|--------|-------|-------|---------|-------|-------|---------|---------------|---------|
| FM4824-LP | 14.0" | 47.75" | 23.75" | 46.0" | 22.0" | 18.0"^^ | 18.0" | 18.0" | 36"X12" | 1,000 - 2,500 | 14 - 36 |
| FM4836-LP | 16.0" | 47.75" | 35.75" | 46.0" | 34.0" | - | 18.0" | 30.0" | 33"X21" | 2,000 - 4,500 | 25 - 45 |

*THROW DISTANCE IN FEET FOR TERMINAL VELOCITY OF 150 FPM AND 50 FPM
^^GRILLE SIZE

EP Custom Products, Inc.- 7823 Commerce Drive, PO Box 1118, Denver, North Carolina, 28037 704.483.8745

www.epcustomproducts.com

| | |
|--|--|
|  EP CUSTOM PRODUCTS <small>ENDLESS POSSIBILITIES</small> | FLUSH MOUNT CONCENTRIC DIFFUSER MODELS FM824-4836 4-WAY THROW LOW PROFILE |
| | SUBMITTED TO: |
| DATE: 09-21-21 REVISION #: 3 | Items subject to change without notice. EP Custom Products is not responsible to notify of changes or updates in product design. Copyright 2021. |